

MURANO

—

Libertà compositiva, bellezza quotidiana | Compositional freedom, everyday beauty



Murano

Equilibrio contemporaneo per vivere l'outdoor.

Murano nasce per interpretare gli spazi esterni con sobrietà e carattere. È un set d'arredo pensato per accompagnare la quotidianità all'aperto con soluzioni pratiche, ordinate e visivamente leggere. La pulizia delle forme, la continuità delle superfici e la solidità dei materiali definiscono uno stile attuale, essenziale, senza eccessi. Un progetto che dialoga con ambienti diversi, dal giardino privato agli spazi condivisi, mantenendo sempre coerenza e misura.

Con Murano, l'outdoor diventa un'estensione naturale del vivere contemporaneo.

Contemporary balance for outdoor living.

Murano was created to shape outdoor spaces with simplicity and character. It is a furniture set designed to accompany everyday outdoor living with practical, well-ordered and visually light solutions. Clean lines, continuous surfaces and solid materials define a contemporary, essential style without excess. A project that adapts naturally to different settings, from private gardens to shared spaces, always maintaining coherence and balance.

With Murano, the outdoors becomes a natural extension of contemporary living.



Modularità.

Quando il design si fa flessibile.

Murano è pensato per chi desidera flessibilità senza rinunciare all'estetica. Ogni elemento è progettato per combinarsi in modo intuitivo, dando vita a composizioni dinamiche, proporzionate e sempre nuove. Un solo set, dieci modi diversi di vivere il tuo spazio outdoor.

Modularity.

When design becomes flexible.

Murano is designed for those who seek flexibility without compromising on aesthetics. Each element is created to combine effortlessly, giving rise to dynamic, well-balanced and ever-evolving compositions. One set, ten different ways to enjoy your outdoor space.



CUSCINI
SFODERABILI E IDROREPELLENTI

CUSHIONS
REMOVABLE COVERS AND
WATER-REPELLENT

UN IMBALLO UNICO
PER MOLTEPLICI APPLICAZIONI

SINGLE PACKAGING
FOR MULTIPLE APPLICATIONS

MONTAGGIO
FACILE

ASSEMBLY
EASY

Due poltrone | Divano tre posti | Tavolino
Two armchairs | Three-seater sofa | Coffee table



CONVIVALITÀ COMPATTA

Ideale per ospitare con semplicità e comfort.

COMPACT GATHERINGS

Ideal for hosting with ease and comfort.

Poltrona | Divano quattro posti | Tavolino
Armchair | Four-seater sofa | Coffee table



EQUILIBRIO ALLUNGATO

Quando serve un posto in più, senza perdere stile.

EXTENDED BALANCE

When you need an extra seat, without compromising on style.

Divano due posti | Divano tre posti | Tavolino
Two-seater sofa | Three-seater sofa | Coffee table



CONVERSAZIONE A DUE LIVELLI

Due moduli indipendenti per creare dinamismo nello spazio.

DUAL-LEVEL SEATING

Two independent modules to create dynamism in your space.

Due divani due posti | Poltrona | Tavolino
Two two-seater sofas | Armchair | Coffee table



ALTERNANZA FLUIDA

Libertà compositiva e armonia tra volumi.

FLUID RHYTHM

Compositional freedom and harmony between volumes.

Divano cinque posti | Tavolino
Five-seater sofa | Coffee table



COMFORT LINEARE

Una soluzione ampia, essenziale, dal forte impatto visivo.

LINEAR COMFORT

A spacious, minimalist composition with striking visual presence.

Divano cinque posti (sovrapposto) | Tavolino
Five-seater sofa (stackable) | Coffee table



SOLUZIONE SOVRAPPOSTA

Una composizione compatta per ottimizzare lo spazio.

OVERLAPPING SOLUTION

A compact composition to optimise space.

Poltrona con poggiatesta | Divano tre posti | Tavolino
Armchair with footrest | Three-seater sofa | Coffee table



RELAX PERSONALE

Un angolo intimo per leggere, rilassarsi, respirare.

PERSONAL RELAXATION

A cozy corner for reading, relaxing, and unwinding.

Divano quattro posti | Poggiatesta | Tavolino
Four-seater sofa | Footrest | Coffee table



DESIGN DESTRUTTURATO

Geometrie libere per spazi che cambiano ogni giorno.

UNSTRUCTURED DESIGN

Free-form geometry for spaces that change every day.

Divano tre posti | Poggiapiedi | Poltrona | Tavolino
Three-seater sofa | Footrest | Armchair | Coffee table



MIX DINAMICO

Il tuo salotto outdoor, modulato su più livelli di comfort.

DYNAMIC MIX

Your outdoor living room, designed for multiple levels of comfort.

Tre poltrone | Poltrona con poggiatesta (senza braccioli) | Tavolino
Three armchairs | Armchair with footrest (without armrests) | Coffee table



SOLUZIONE LEGGERA

Una composizione ariosa, versatile, sempre pronta a cambiare.

LIGHT SOLUTION

An airy, versatile composition, always ready to adapt.

Colori | Color



Bianco // Beige | White // Beige



Bianco // Blu | White // Blue



Juta // Beige | Jute // Beige



Juta // Blu | Jute // Blue



Antracite // Beige | Anthracite // Beige



Antracite // Blu | Anthracite // Blue

Set Sofà Murano in Polipropilene e Fiberglass Trattamento Anti UV







1 x divano a 3 posti + 2 poltrone + 1 tavolino da caffè + 5 cuscini seduta + 5 cuscini schienale
 Prodotto in kit, pronto da montare



Polypropylene Fiberglass with Anti-UV Treatment Sofa Set Murano

1 x 3 seater sofa + 2 armchairs + 1 coffee table + 5 seat and 5 back cushions

Ready to assemble

COLORI COLORS	CODICE ITEM CODE	COD.EAN EAN CODE
 BIANCO C/BEIGE WHITE C/BEIGE	S7729BBE	8.005.465.975.667
 BIANCO C/BLU WHITE C/BLU	S7729BBL	8.005.465.975.605
 JUTA C/BEIGE JUTE C/BEIGE	S7729JBE	8.005.465.975.674
 JUTA C/BLU JUTE C/BLUE	S7729JBL	8.005.465.975.612
 ANTRACITE C/BEIGE ANTHRACITE C/BEIGE	S7729YBE	8.005.465.975.681
 ANTRACITE C/BLU ANTHRACITE C/BLU	S7729YBL	8.005.465.975.629

LOGISTICA | LOGISTIC

		PESO WEIGHT (kg)
PZ. CARTONE PCS. BOX	1	55
DIM. CARTONE BOX SIZE (cm)	139 x 81,5 x 62 h	
N. CARTONI PALLET N. BOXES PALLET	4	
PZ. PALLET PCS. PALLET	4	
MISURE PALLET PALLET DIM. (cm)	139 x 81,5 x 259,5 h	
PZ. BILICO PCS. TRUCK	112	
PZ. 40' CTR PCS. 40' CTN	88	

* La seduta è 50 cm se porta il cuscino | Seat 50 cm with cushion

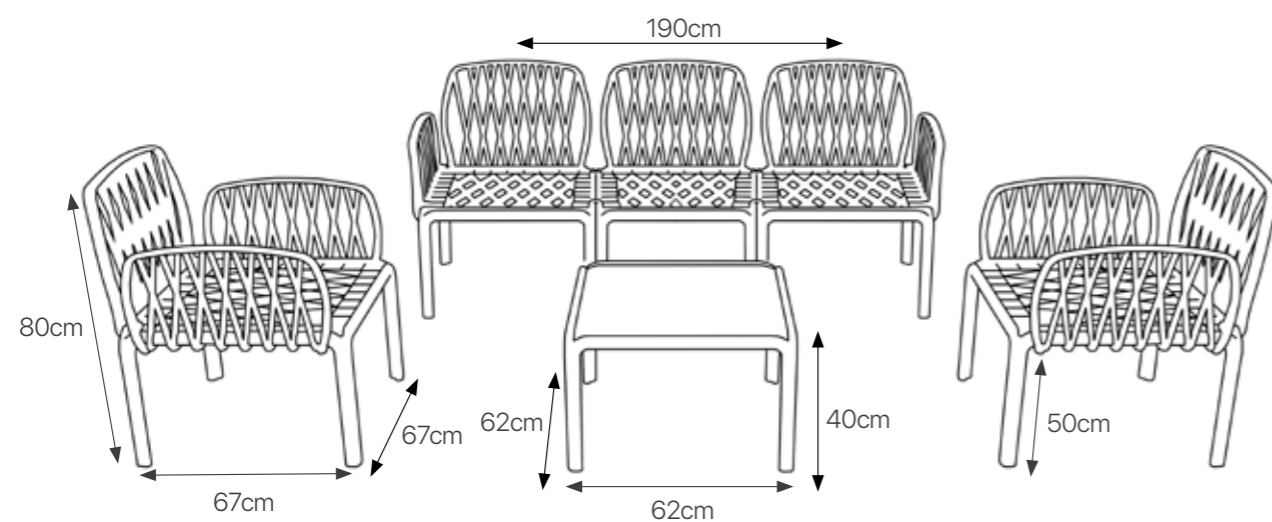

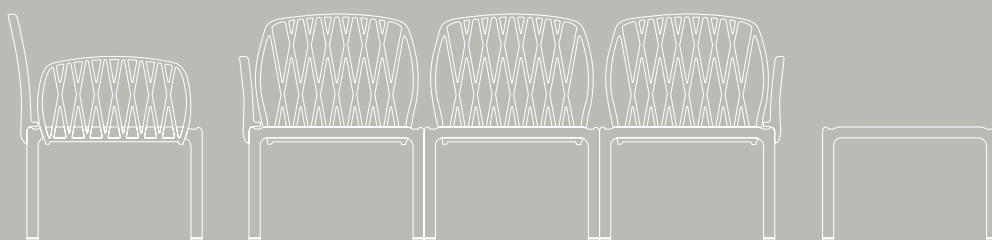

www.grandsoleilspa.it



**STABILIMENTI E
UFFICI COMMERCIALI**

IGAP S.p.A. | Via Garibaldi 244
46013 Canneto S/Oglio (MN)
Italy

TEL:
+39.0376.7172200

FAX:
+39.0376.7172290

EMAIL:
grandsoleil@grandsoleilspa.it